

---

**DNBSEQ-G400RS Stereo-seq  
Visualization Reagent Set**

**Instructions for Use**

---

**For Research Use Only.  
Not for use in diagnostic procedures.**

---

Complete Genomics, Inc.

Part No.: H-020-000919-00

---

## About the Instructions for Use

**CG intends to provide this product solely for research use.**

This Instructions for Use is applicable to DNBSEQ-G400RS Stereo-seq Visualization Reagent Set. The Instructions for Use version is 3.0 and the set version is 1.0.

This Instructions for Use and the information contained herein are proprietary to Complete Genomics, Inc. (hereinafter referred to as CG), and are intended solely for the contractual use of its customers in the use of the products described herein and for no other purpose. This Instructions for Use and its contents shall not be reprinted, reproduced, modified, distributed, or disclosed to others, in whole or in part, without prior written consent from CG.

CG makes no commitment to this Instructions for Use, including (but not limited to) any special commercial purpose and any reasonable implied warranties. CG has taken measures to ensure the correctness of this Instructions for Use. However, CG is not responsible for any missing parts of the Instructions for Use, and reserves the right to revise the Instructions for Use and modify the device, so as to improve the reliability, performance or design.

Figures in this Instructions for Use are for illustrative purpose only. The content might be slightly different from the device. For the most up-to-date details, refer to the device purchased.

DNBSEQ™ is a trademark of CG or its affiliates in the U.S. and/or other countries. Qubit™ is the trademark of Thermo Fisher Scientific, or its subsidiaries. Other names and trademarks mentioned in this Instructions for Use are the property of their respective companies and subsidiaries.

©2024-2025 Complete Genomics, Inc. All rights reserved.

---

## Revision history

	Date	Version
Add FF V1.3 library sequencing	January 20, 2025	3.0
Update product name	June 24, 2024	2.0
Initial release	April 22, 2024	1.0

## Contents

<b>Visualization set overview</b>	<b>1</b>
Application	2
Sequencing technology	2
Data analysis	2
Sequencing read length	2
Sequencing and analysis times	3
Biological safety	4
List of Stereo-seq Visualization set components	5
User-supplied equipment and consumables	6
<b>Sequencing</b>	<b>9</b>
Workflow	10
Preparing DNBs	11
.....	
Recommended library insert size	11
.....	
DNA library concentration and amount requirement	11
.....	
Making DNBs	12
Quantifying DNBs	16
.....	
Quantifying DNBs	16
Preparing the flow cell	16
Loading DNBs	18
.....	
Loading DNBs by the sequencer	18
.....	
Loading DNBs by DL-200H	19
Preparing the Sequencing Reagent Cartridge	24
Performing a sequencing run	31
.....	
Entering DNB ID	31
.....	
Selecting sequencing parameters	32
.....	
Loading the Sequencing Reagent Cartridge	33
.....	
Loading the flow cell	35

.....	38
Reviewing parameters	38
.....	40
Starting sequencing	40
.....	40
Performing a maintenance wash	40
.....	41
Disposing of the Sequencing Reagent Cartridge and flow cell	41
<hr/>	
<b>Device maintenance</b>	<b>43</b>
.....	44
Service plan	44
.....	44
Sequencer maintenance	44
.....	44
Wash	44
<hr/>	
<b>FAQs</b>	<b>53</b>
.....	54
Reagent FAQs	54
<hr/>	
<b>Instructions for using Qubit to quantify the DNBs</b>	<b>59</b>
<hr/>	
<b>Research use only</b>	<b>61</b>
<hr/>	
<b>Manufacturer information</b>	<b>63</b>
<hr/>	
<b>Order information</b>	<b>65</b>
<hr/>	
<b>Acronyms and abbreviations</b>	<b>67</b>

# 01

## Visualization set overview

This chapter describes the sequencing sets information.

---

## Application

**WARNING**

**This kit is intended only for scientific research and should not be used for clinical diagnosis.**

DNBSEQ-G400RS Stereo-seq Visualization Reagent Set is compatible with Stereo-seq FF V1.3 and Stereo-seq OMNI FFPE libraries constructed using the Stereo-seq 16 Barcode Library Preparation Kit (Cat. No.: 111KL160). This stereo-seq visualization reagent set is intended to be used for scientific research only and cannot be used for clinical diagnosis.

---

## Sequencing technology

This stereo-seq visualization reagent set utilizes DNBSEQ technology. A sequencing run starts with the hybridization of a DNA anchor, then a fluorescent probe is attached to the DNA Nanoball (DNB) using combinatorial probe anchor sequencing (cPAS) chemistry. Finally, the high-resolution imaging system captures the fluorescent signal. After digital processing of the optical signal, the sequencer generates high-quality and accurate sequencing information.

---

## Data analysis

During the sequencing run, the control software automatically runs basecalling analysis software and delivers raw sequencing data outputs for secondary analysis.

---

## Sequencing read length

Sequencing read length determines the number of sequencing cycles for a given sequencing run. For example, a PE25+59 cycle run performs Read1 of 25 cycles and Read2 of 59 cycles for a total of 84 cycles. At the end of the insert sequencing run, an extra 10 cycles of barcode read can be performed if required.




Table 1 Sequencing cycle

Library type	Sequencing read length	Read1 read length	Read2 read length	Barcode read length	Total read length	Maximum cycles
OMNI FFPE	PE25+59	25	59	10	26+60+10	172
FF V1.3	PE50+100	50(dark reaction cycle is from 26 to 40)	100	10	51+101+10	172

## Sequencing and analysis times

Table 2 FCL Sequencing and analysis times for each read length (hr)

/	OMNI FFPE (PE25+59)	FF V1.3 (PE50+100)
Single Flow Cell	19.5	30.0
Dual Flow Cells	20.5	31.0
Data analysis (Single Flow Cell)	0.3	0.4
Data analysis (Dual Flow Cells)	0.6	0.8

-  The sequencing time (Single Flow Cell/Dual Flow Cells) in the table above includes the time required from post-loading prime to sequencing completion. The data analysis time includes the time required for barcode demultiplexing (if Split barcode is selected) and FASTQ files output when sequencing is completed.
- The time in the table above is theoretical. The actual run time may vary among various sequencers.














---

## Biological safety

- Reagents and waste chemicals may cause personal injury through skin, eye, or mucosal contact. Follow the safety standards of your laboratory and wear protective equipment (such as a laboratory coat, protective glasses, a mask, gloves, and shoe covers) when using the kit.
- If you accidentally splash reagents or waste liquids on your skin or into your eyes, immediately flush the affected area with plenty of water and seek medical aid immediately.
- When disposing of expired reagents, waste liquids, waste samples, and consumables, comply with local regulations.
- Use and store the reagents according to the Instructions for Use. Failure to do so may negatively impact performance.
- Check the expiration date of all reagents before use. Using expired reagents may cause inaccurate results.

## List of Stereo-seq Visualization set components

**Table 3 DNBSEQ-G400RS Stereo-seq Visualization Reagent Set (G400 STO FCL PE75)**  
Cat. No.: 940-001885-00

Component	Cap color	Spec & quantity	Storage temperature	Transportation temperature	Expiration date
DNBSEQ-G400 FCL Sequencing Flow Cell	/	1 EA	-25 °C to -15 °C	-80 °C to -15 °C	10 months
Low TE Buffer		300 µL/tube×1 tube			
STO Make DNB Buffer		80 µL/tube×1 tube			
Make DNB Enzyme Mix I (OS)		160 µL/tube×1 tube			
Make DNB Enzyme Mix II (OS)		8 µL/tube×1 tube			
Stop DNB Reaction Buffer		100 µL/tube×1 tube			
DNB Load Buffer I		200 µL/tube×1 tube			
DNB Load Buffer II		200 µL/tube×1 tube			
Microcentrifuge Tube 0.5 mL (Empty)		1 tube			
dNTPs Mix		0.70 mL/tube×1 tube			
dNTPs Mix II		0.96 mL/tube×1 tube			
Sequencing Enzyme Mix II		2.00 mL/tube×1 tube			
Inactive MDA Reagent		3.50 mL/tube×1 tube			
MDA Enzyme Mix II		0.50 mL/tube×1 tube			
Sequencing Reagent Cartridge	/	1 EA			
Transparent sealing film	/	2 sheets			

## User-supplied equipment and consumables

Before using the kit, prepare the following equipment:

**Table 4 User-supplied equipment list**

Equipment	Recommended brand
Ultra-pure water machine	General lab supplier
Freezer, -25 °C to -15 °C	General lab supplier
Refrigerator, 2 °C to 8 °C	General lab supplier
Graduated cylinder, 500 mL	General lab supplier
Ice bucket	General lab supplier
Pipette, 20 µL	Eppendorf or equivalent
Pipette, 200 µL	Eppendorf or equivalent
Pipette, 1000 µL	Eppendorf or equivalent
Electronic pipette	Intergra or equivalent
Vortex mixer	General lab supplier
Qubit Fluorometer	Thermo Fisher
Thermal cycler	Bio-Rad or equivalent
Mini spinner	General lab supplier
Ultrasonic cleaner	General lab supplier

It is recommended to use the following reagents/consumables:

 Tips are disposable consumables. Do not reuse them.

**Table 5 Recommended reagent/consumable list**

Reagent/Consumable	Recommended brand	Purpose
2 M NaOH	General lab supplier	Instrument washes
5 M NaCl	General lab supplier	Instrument washes
Tween-20	Sigma-Aldrich, Cat. No.: P7949	Performing a maintenance wash
Sterile pipette tip (various types)	General lab supplier	Pipetting and loading solutions
Sterile 200 µL wide-bore, non-filtered pipette tip	AXYGEN, Cat. No.: T-205-WB-C	Mixing DNBS

Reagent/Consumable	Recommended brand	Purpose
Qubit ssDNA Assay Kit	Thermo Fisher	DNB QC
Qubit dsDNA Assay Kit	Thermo Fisher	Library QC
Qubit Assay Tubes	Thermo Fisher	Library and DNB QC
Sterile PCR 8-strip tube, 0.2 mL	Thermo Fisher	Making DNB reaction mixture
Sterile microcentrifuge tube, 1.5 mL	VWR, Cat. No.: 20170-038, or equivalent	Combining volumes when diluting NaOH and library
Sterile Microcentrifuge tube, 2.0 mL	General lab supplier	DNB Loading needle washing tube
Sterile Centrifuge tube, 5 mL	General lab supplier	For reagent mix
Canned air duster	General lab supplier	Cleaning
Disposable gloves, powder-free	General lab supplier	General purpose
Kimwipes	VWR	Cleaning
Low-lint cloth	General lab supplier	Cleaning
Laboratory-grade water	General lab supplier	/

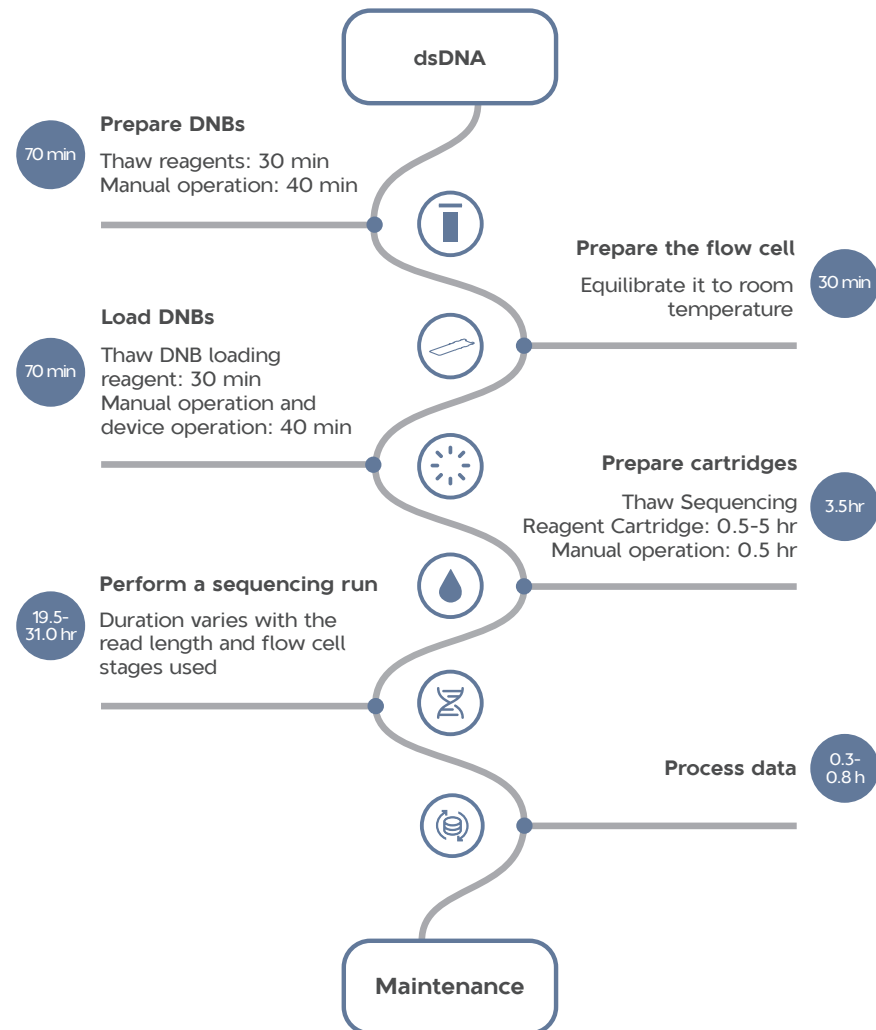
---This page is intentionally left blank.---

# 02

## Sequencing

This chapter describes the sequencing workflow, sequencing and analysis, and post-sequencing procedures by using the flow cell A operation area as an example. Read and follow the instructions to ensure correct operations.

## Workflow



**Figure 1 DNBSEQ-G400RS Sequencing workflow**



- Reagents and waste chemicals may cause personal injury through skin, eye, or mucosal contact. Follow the safety standards of your laboratory and wear protective equipment (such as a laboratory coat, protective glasses, mask, gloves, and shoe covers) when using the device.
- If you accidentally splash reagents or waste liquids on the skin or into eyes, immediately flush the affected area with large amounts of water, and seek medical aid immediately.
- When disposing of expired reagents, waste liquids, waste DNBs, and consumables, comply with local regulations.



## Preparing DNBs

### Recommended library insert size

The stereo-seq visualization reagent set is compatible with libraries constructed using the Stereo-seq OMNI Transcriptomics Set for FFPE or the Stereo-seq Transcriptomics Sets for FF V1.3. The recommended size distribution of OMNI FFPE inserts ranges between 150 bp and 1000 bp, with the main insert size fragment centered within  $\pm 100$  bp. The recommended size distribution of FF V1.3 inserts ranges between 200 bp and 600 bp, with the main insert size fragment centered within  $\pm 100$  bp.

- i** If there are any special requirements or specifications for the library preparation kit, then the requirements of the kit should be followed.

**Table 6 Recommended library insert size**

Library type	Read length	Recommended library insert distribution (bp)	Data output (M/lane)
OMNI FFPE	PE25+59	150 to 1000	~320
FF V1.3	PE50+100	200 to 600	~320

- i** Average data output will vary with library types and applications.

### DNA library concentration and amount requirement

The concentration of the OMNI FFPE library should be no less than 3 ng/ $\mu$ L. The concentration of the FF V1.3 library should be no less than 20 fmol/ $\mu$ L.

- i**
- If the library concentration is unknown, it is recommended to perform dsDNA library quantitation C (ng/ $\mu$ L) by using Qubit HS dsDNA Assay Kit and Qubit Fluorometer.

$$C(\text{fmol}/\mu\text{L}) = \frac{3030 \times C(\text{ng}/\mu\text{L})}{N \times 2}$$

N represents the average number of basepairs within the DNA fragments (the lengths of which includes associated adapter sequences). C (ng/ $\mu$ L) represents the DNA library concentration.

- If there are any special requirements or specifications for the library preparation kit, then the requirements of the kit should be followed.

## Making DNBs




- i** • Mixed use of reagent components from different batches is not recommended.
- For transferring or mixing DNBs, use the wide-bore, non-filtered pipette tips.
- For preparing other reagents, use a proper pipette tip according to the instructions..

### Preparing reagents for making DNBs

Perform the following steps:


1. Place the libraries on ice until use.
2. Take the following reagents out of the stereo-seq visualization reagent set and thaw them at room temperature.

**Table 7 Reagent preparation 1**

Component	Cap color
Low TE Buffer	
STO Make DNB Buffer	
Stop DNB Reaction Buffer	

3. Take [Make DNB Enzyme Mix I \(OS\)](#) out of the stereo-seq visualization reagent set and thaw the reagent for approximately 30 min on ice.

**Table 8 Reagent preparation 2**

Component	Cap color
Make DNB Enzyme Mix I (OS)	

4. Mix the reagents by using a vortex mixer for 5 sec. Centrifuge briefly and then place it on ice until use.

- i** Mixed use of reagent components from different batches is not recommended.

### Calculating the number of DNB reactions

- Using the sequencer to load DNBs:  
All lanes in the flow cell must be loaded with the same DNBs.
- Using DNBSEQ-G400RS mini loader DL-200H to load DNBs:  
Different DNBs can be loaded into different lanes.

**Table 9** Required number of make DNB reactions for each flow cell

Flow Cell type	Loading system	DNB volume ( $\mu\text{L}$ ) / lane	Make DNB reaction ( $\mu\text{L}$ )	Required number of make DNB reactions / flow cell
FCL	Sequencer	50	100	2
	DL-200H	25	100	2 to 4

## Calculating the required amount of dsDNA libraries

The required volume of dsDNA libraries is determined by the required library amount and library concentration quantified in *DNA library concentration and amount requirement on Page 11*.

- i** If there are any special requirements or specifications for the library preparation kit, then the requirements of the kit should be followed.
- $C1$  represents the OMNI FFPE library concentration in *DNA library concentration and amount requirement on Page 11*.  $C2$  represents the FF V1.3 library concentration in *DNA library concentration and amount requirement on Page 11*.
- Calculate the required dsDNA libraries for each Make DNB reaction and fill it in as  $V$  according to *Table 11 on Page 14*.

**Table 10** Volume of dsDNA libraries

Library type	Required dsDNA volume of 100 $\mu\text{L}$ DNB reaction ( $\mu\text{L}$ )
FFPE dsDNA	$V = 60 \text{ ng} / C1$
FF V1.3 dsDNA	$V = 400 \text{ fmol} / C2$



## Making DNBs

Perform the following steps:

- Take out a 0.2 mL PCR tube. Prepare *Make DNB Reaction Mixture 1* according to the table below:

- i** The following table illustrates the volume used for one DNB reaction. The required number of make DNB reactions are determined by the loading method as described in *Calculating the number of DNB reactions on Page 12*.



**Table 11 Make DNB Reaction Mixture 1**

Component	Cap color	Volume (μL)
Low TE Buffer		20 - V
STO Make DNB Buffer		20
dsDNA libraries	/	V
<b>Total volume</b>		40



- Mix the reaction mixture thoroughly by using a vortex mixer, centrifuge for 5 sec by using a mini spinner, and place it on ice until use.
- Place the mixture into a thermal cycler and start the primer hybridization reaction. Thermal cycler settings are shown in the table below:


**Table 12 Primer hybridization reaction conditions**

Temperature	Time
105 °C (heated lid)	On
95 °C	3 min
40 °C	3 min
4 °C	Hold

- Remove [Make DNB Enzyme Mix II \(OS\)](#) from the DNBSEQ-G400RS Stereo-seq Visualization Reagent Set and place it on ice. Centrifuge briefly for 5 sec by using a mini spinner and place on ice.
  -  Do not keep [Make DNB Enzyme Mix II \(OS\)](#) at room temperature.
  - Avoid holding the tube for a prolonged time.
- Take the [Make DNB Reaction Mixture 1](#) tube out of the thermal cycler when the temperature reaches 4 °C.
- Centrifuge briefly for 5 sec, and then place the tube on ice. Prepare the [Make DNB Reaction Mixture 2](#) according to the table below.
  -  Do not discard the [Make DNB Enzyme Mix II \(OS\)](#) after you complete this step; it will be used in DNB loading operations.

**Table 13 Make DNB Reaction Mixture 2**

Component	Cap color	Volume (μL)
Make DNB Enzyme Mix I (OS)		40
Make DNB Enzyme Mix II (OS)		2
<b>Total volume</b>		42

7. Add all of the [Make DNB Reaction Mixture 2](#) into the [Make DNB Reaction Mixture 1](#). Mix the reaction mixture thoroughly by using a vortex mixer, and centrifuge for 5 sec by using a mini spinner.
8. Place the tubes into the thermal cycler for the Rolling Circle Amplification (RCA) reaction. The conditions are shown in the table below.
  -  • The reaction procedures for FF V1.3 library and FFPE library are different. Select the corresponding procedure according to actual needs.
  - When a reaction protocol is run, some sample blocks of thermal cyclers may remain at ambient temperatures while the lid is being heated or cooled to operating temperature. For these types of thermal cyclers, pre-heating of the heated lid is required to ensure that the heated lid is at operating temperature during the DNB reactions.
  - It is recommended to set the temperature of the heated lid to 35 °C or as close as possible to 35 °C.

- RCA conditions for FF V1.3 library:

**Table 14 RCA conditions for FF V1.3 library**

Temperature	Time
35 °C (heated lid)	On
30 °C	25 min
4 °C	Hold

- RCA conditions for OMNI FFPE library:

**Table 15 RCA conditions for OMNI FFPE library**

Temperature	Time
35 °C (heated lid)	On
30 °C	30 min
4 °C	Hold

9. When the temperature reaches 4 °C, immediately add 20 µL [Stop DNB Reaction Buffer](#) into the RCA reaction tube. Mix gently by pipetting 8 times by using a wide-bore, non-filtered pipette tip.

- i** • It is very important to mix DNBs gently by using a wide-bore, non-filtered pipette tip.
- Do not centrifuge, vortex, or shake the tube.
- Store the DNBs at 4 °C and perform sequencing within 48 hr (about 2 days).

---

## Quantifying DNBs

---

### Quantifying DNBs

When DNB production is complete, take 2 µL of DNBs, and use the Qubit ssDNA Assay Kit and the Qubit Fluorometer to quantify the DNBs. The DNB concentration should be no less than 8 ng/µL. For details, refer to *Instructions for using Qubit to quantify the DNBs on Page 59*.

- i** If there are more than 8 samples to quantify, it is recommended to quantify in batches to avoid inaccurate DNB quantification as the result of fluorescence quenching.

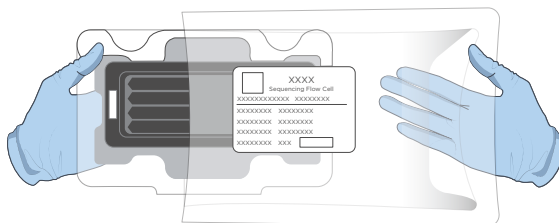
---

## Preparing the flow cell

Perform the following steps:

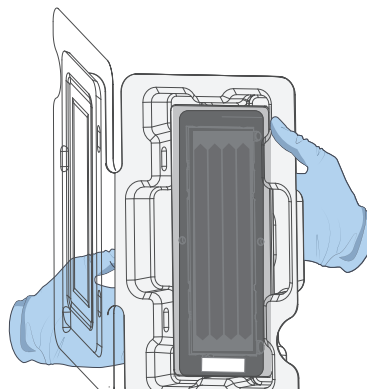
1. Remove the flow cell plastic package from the Stereo-seq Visualization reagent set.
  - i** Do not open the outer plastic package yet.
2. Place the plastic package at room temperature for 30 min to 24 hr.

3. Unwrap the outer plastic package before use.



**Figure 2** Unwrapping the outer plastic package

- i • If the flow cell will not be used within 24 hr after being placed at room temperature and the outer plastic package is intact, the flow cell can be returned to -25 °C to -15 °C for storage. But the switch between room temperature and -25 °C to -15 °C must not exceed 3 times.
  - If the outer plastic package has been opened but the flow cell cannot be used immediately, store the flow cell at room temperature and use it within 24 hr. If storage exceeded 24 hr, it is not recommended to use the flow cell.
4. Take the flow cell out of the inner package and inspect it to ensure that the flow cell is intact and free of debris.



**Figure 3** Inspecting the flow cell

## Loading DNBs



### Loading DNBs by the sequencer

#### Preparing reagents

Perform the following steps:

1. Remove the [DNB Load Buffer II](#) from storage and thaw it on ice for approximately 30 min.
2. After thawing, mix it by using a vortex mixer for 5 sec, centrifuge briefly by using a mini spinner, and place it on ice until use.
  - i** If crystal precipitation is visible in [DNB Load Buffer II](#), vigorously mix the reagent for 2 min by using a vortex mixer to dissolve the precipitation before use.
3. Take a 0.5 mL microcentrifuge tube out of the sequencing set and add the following reagents:

**Table 16 DNB loading mixture 1**

Model	Component	Cap color	Volume (μL)
G400 STO FCL PE75	DNB Load Buffer II		64
	Make DNB Enzyme Mix II (OS)		2
	DNBs	/	200
	<b>Total Volume</b>	/	266

4. Combine the components and mix them by gently pipetting 8 times by using a wide-bore, non-filtered pipette tip. Place the mixture at 2 °C to 8 °C until use.
  - i**
    - Do not centrifuge, vortex, or shake the tube.
    - Prepare a fresh [DNB loading mixture 1](#) immediately (within 10 min) before the sequencing run.
    - Each flow cell requires 266 μL of [DNB loading mixture 1](#).

#### Loading DNBs

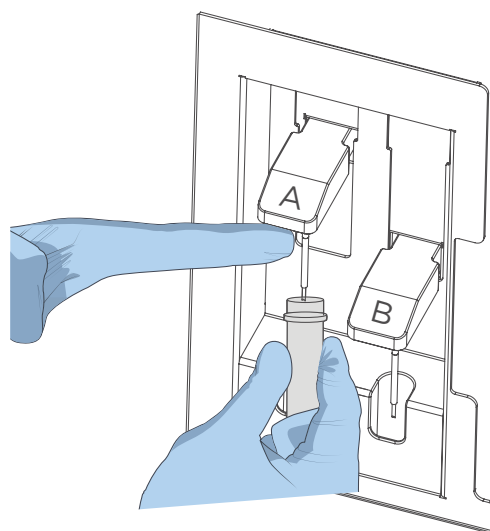
Perform the following steps:

1. Open the reagent compartment door.



2. Gently lift the DNB loading needle with one hand, remove the cleaning reagent tube with the other hand, load the sample tube prepared in *Preparing reagents on Page 18*, and then slowly lower the DNB loading needle until the tip reaches the bottom of the tube.

**i** Perform this step if you load DNBs by the sequencer, if not, use an empty tube.



**Figure 4 Loading the DNB tube**

3. Close the reagent compartment door.
4. Select the DNB loading box in the DNB ID entry interface. After you prepare the Sequencing Reagent Cartridge, perform the sequencing run according to *Performing a sequencing run on Page 31*.
5. For the next step, refer to *Loading the Sequencing Reagent Cartridge on Page 33*.

---

## Loading DNBs by DL-200H



---

### Preparing reagents


Perform the following steps:

1. Take out a new PCR 8-strip tube and add the reagents listed in the table below:

Table 17 DNB loading mixture 2


Model	Component	Cap color	Volume (μL)
			FCL
G400 STO FCL PE75	DNB Load Buffer II		8
	Make DNB Enzyme Mix II (OS)		0.25
	DNBs	/	25
	<b>Total Volume</b>	/	33.25

2. Combine the components and mix them by gently pipetting 8 times by using a wide-bore, non-filtered pipette tip. Place the mixture at 2 °C to 8 °C until use.

-  • Do not centrifuge, vortex, or shake the tube.
- Each lane requires at least 30 μL of DNB loading mixture 2.
- Prepare a fresh DNB loading mixture 2 immediately before the sequencing run.

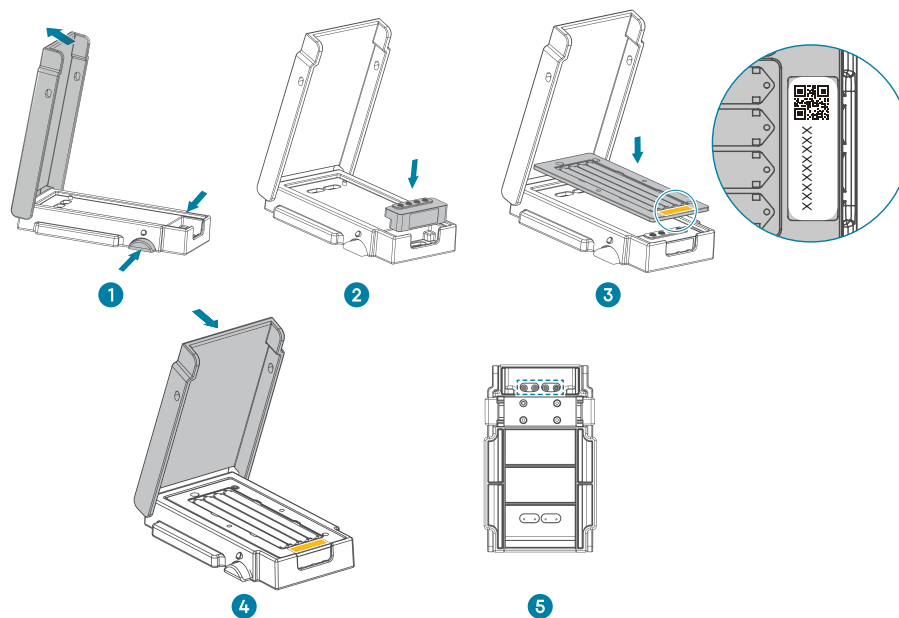
---

## Loading DNBs

-  • Ensure that the DL-200H is properly maintained.
- Ensure that the sealing gasket of the DL-200H is clean and properly maintained.

Perform the following steps:

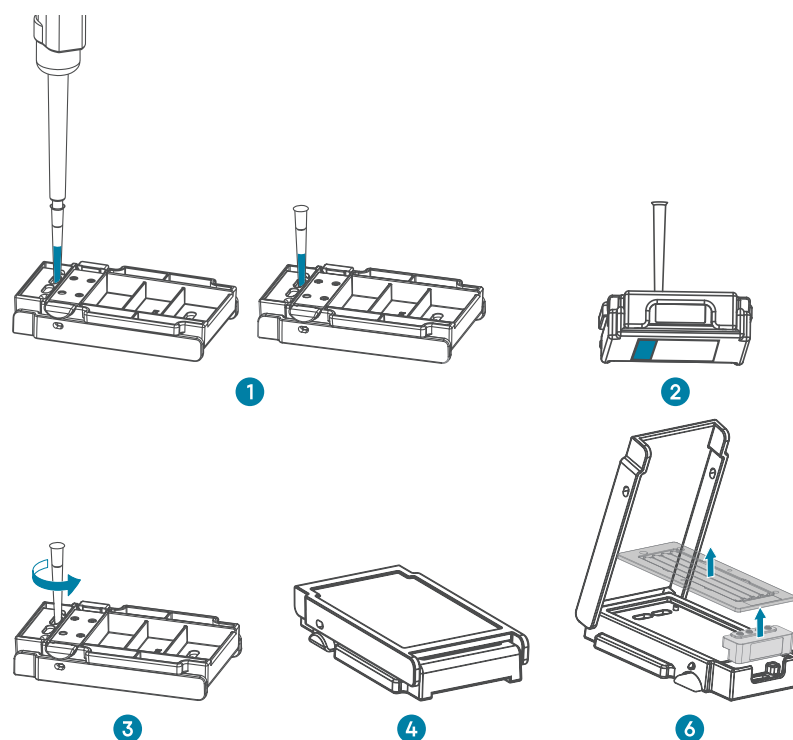
1. Install the sealing gasket and the flow cell.



**Figure 5** Installing sealing gasket and flow cell

- 1) Press the latches and open the cover.
- 2) Place a clean sealing gasket into the groove and ensure that the gasket surface is even.
- 3) Align the holes of the flow cell with the alignment pins of the device and place the flow cell on it.
  - i** Ensure that the label of the flow cell is facing upward and in the same position as the sealing gasket.
- 4) Close the cover and ensure that the cover is securely closed.
- 5) Place the back of the DL-200H facing upward, and check whether the fluidics inlets align with the holes of the sealing gasket and ensure that the holes are clean.

2. Load DNBs by using the DL-200H.



**Figure 6 Loading DNBs by using the DL-200H**

1) Place the DL-200H on the laboratory bench with the back facing you. Aspirate 30  $\mu$ L of DNB loading mixture 2 with a wide-bore, non-filtered pipette tip and insert the tip into the fluidics inlet. Eject the tip from the pipette. DNBs will automatically flow into the flow cell.

**i** Do not touch or move the tip when ejecting the tip. Doing so may introduce bubbles into the flow cell.

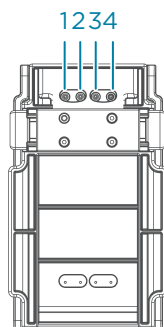
2) Keep DL-200H parallel to the bench and keep the back facing upward. Hold up the device vertically to check whether the DNBs flow into the flow cell.

**! WARNING** During observation, do not tilt the DL-200H. Doing so may cause liquid leakage or even biological contamination.

**i** If DNBs do not flow into the lane, slightly press the top of the pipette tip until DNBs start to flow.

3) Ensure that all DNBs flow into the flow cell. Hold the device and rotate the tip counterclockwise to remove it.

- 4) Repeat steps 1) to 3) to load the DNBs to the remaining lanes. Ensure that you load DNBs to the 4 lanes of the flow cell in ascending order, as shown in the figure below:



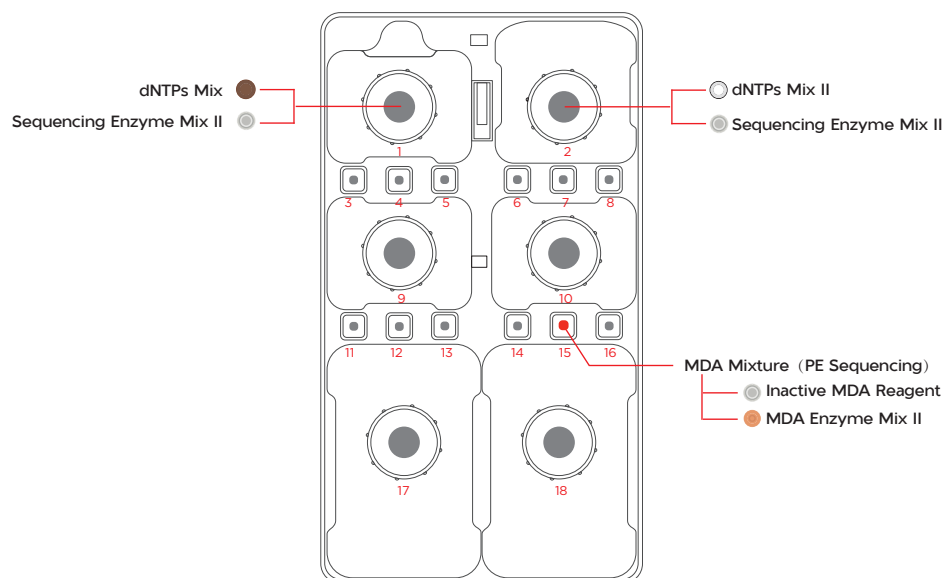
**Figure 7** Lane order of DNB loading

- 5) Place the DL-200H on the bench with the front facing upward and wait 30 min for the DNB loading process.
- 6) Open the cover and take out the flow cell and the sealing gasket.
3. After the DNB loading process is completed, immediately take the flow cell out and transfer it to the sequencer for sequencing. After you have prepared the Sequencing Reagent Cartridge, perform the sequencing run according to *Performing a sequencing run on Page 31*.
4. For the next step, refer to *Performing a sequencing run on Page 31*.

## Preparing the Sequencing Reagent Cartridge

The sequencing enzyme mix and dNTP mixes are provided in different tubes and are packaged together with the Sequencing Reagent Cartridge. Before the sequencing run can be started, an appropriate amount of sequencing enzyme mix and dNTP mixes must be added to well No. 1 and well No. 2 of the Sequencing Reagent Cartridge. Furthermore, MDA Enzyme Mix (MDA: Multiple Displacement Amplification) must be added to well No. 15. If prepared reagent cartridges are not used immediately, refer to *Q: What rules should I follow if I need to store a reagent kit temporarily?* on Page 56.

Perform the following steps:



**Figure 8 Well position**

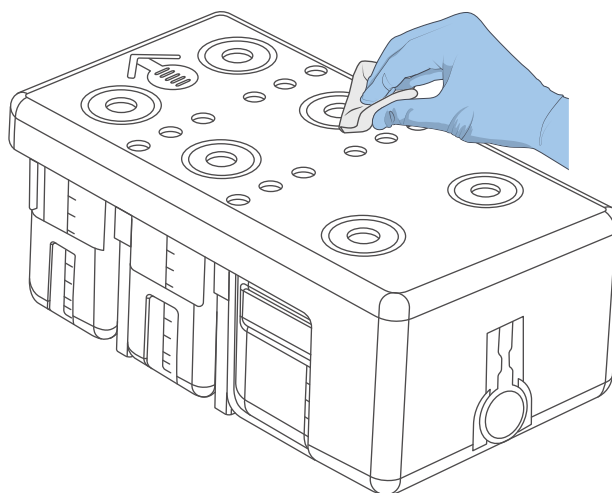
1. Remove the Sequencing Reagent Cartridge from storage.
2. Thaw in a water bath at room temperature until completely thawed (or thaw in a 2 °C to 8 °C refrigerator 1 to 2 days in advance). The approximate time to thaw is listed in the following table. Store it in a 2 °C to 8 °C refrigerator until use.

**Table 18** Approximate thaw times for various sequencing kits

Model	Method		
	Water bath at room temperature (hr)	Refrigerator at 2°C to 8°C overnight then water bath at room temperature (hr)	Refrigerator at 2°C to 8°C (hr)
G400 STO FCL PE75	3.0	1.5	36.0

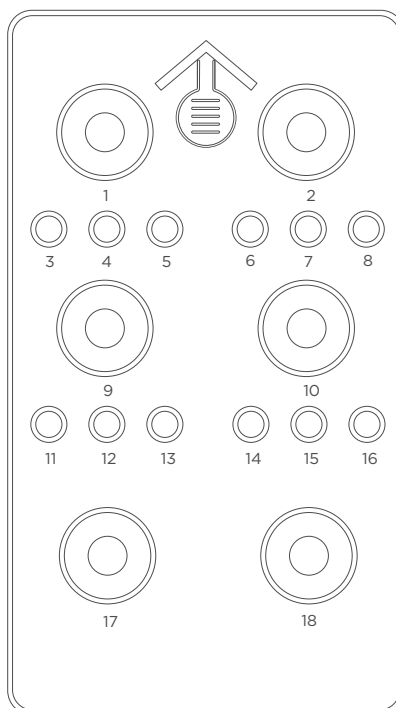
**i** After removing the flow cell from -25 °C to -15 °C, the flow cell must be placed at room temperature for at least 30 min and no longer than 24 hr before DNB loading.

3. Invert the cartridge 3 times to mix before use.
4. Shake the cartridge vigorously up and down 20 times. And shake the cartridge vigorously clockwise 20 times, and then counterclockwise 20 times. Ensure that the reagents are fully mixed.
5. Wipe away any water condensation on the cartridge cover and well surround with a KimWipes tissue.

**Figure 9** Wiping cartridge cover

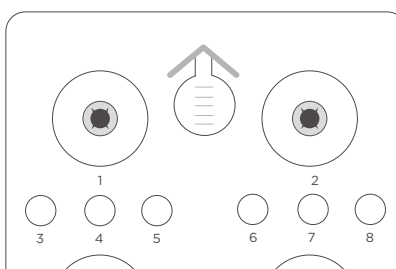
6. Remove dNTPs Mix and dNTPs Mix II from -25 °C to -15 °C storage 1 hr in advance and thaw at room temperature. Store at 2 °C to 8 °C until use.
7. Remove the Sequencing Enzyme Mix II from -25 °C to -15 °C storage and place it on ice until use.
8. Remove the Inactive MDA Reagent from storage and place it on ice until use.

Well positions are shown in the figure below:



**Figure 10 Well positions**

- Pierce the seals in the center of wells No. 1 and No. 2 to make a hole approximately 2 cm in diameter using a 1 mL sterile pipette tip.





**Figure 11 Piercing the seal of cartridge**

- Use a pipette with an appropriate volume range. Add **dNTPs Mix** into a new 5 mL sterile tube, and then add **Sequencing Enzyme Mix II** into the **dNTPs Mix** in the same tube according to *Table 19 on Page 27*.

- i** • Mix the **dNTPs Mix** by using a vortex mixer for 5 sec and centrifuge briefly before use.
- Invert the **Sequencing Enzyme Mix II** 6 times before use.




**Table 19 Reagent preparation for well No. 1**

Model	Volume (mL)	
	dNTPs Mix 	Sequencing Enzyme Mix II 
G400 STO FCL PE75	0.700	1.400



11. Invert the tube 6 times to mix the reagents in the tube before adding the mix into well No. 1.

 When transferring the mixture, pipette carefully to prevent the mixture from spilling out of the reagent tube.

12. Take out a pipette with the appropriate volume range and add reagents according to *Table 20 on Page 27*. Add dNTPs Mix II into a new 5 mL sterile tube, and then add Sequencing Enzyme Mix II into the dNTPs Mix II in the same tube.

-  • Mix the dNTPs Mix II by using a vortex mixer for 5 sec and centrifuge briefly before use.
- Invert the Sequencing Enzyme Mix II 6 times before use.

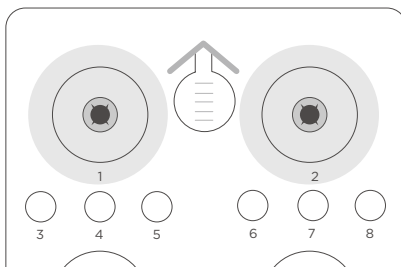
**Table 20 Reagent preparation for well No. 2**

Model	Volume (mL)	
	dNTPs Mix II 	Sequencing Enzyme Mix II 
G400 STO FCL PE75	0.960	0.600

13. Invert the tube 6 times to mix the reagents in the tube before adding the mix into well No. 2.

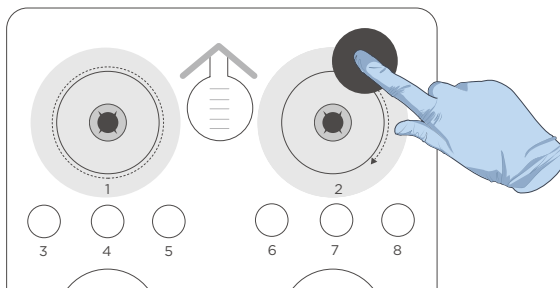
 When transferring the mixture, pipette carefully to prevent the mixture from spilling out of the reagent tube.

- 14. Seal loading wells No. 1 and No. 2 with transparent sealing films.



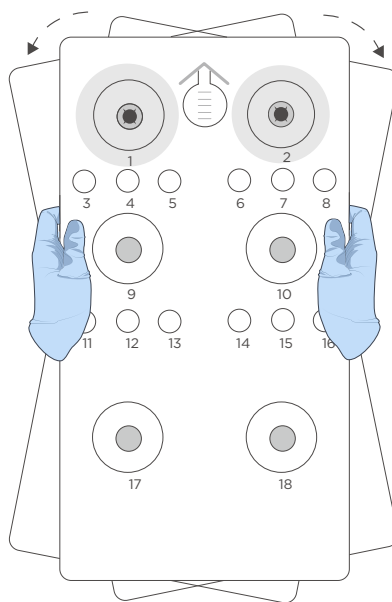
**Figure 12 Sealing the loading wells of the cartridge**

- 15. Press the film around the well with your finger. Ensure that the well is tightly sealed and that no air bubbles exist between the film and the cartridge surface so that the reagents will not flow over the cartridge.



**Figure 13 Sealing the loading wells of the cartridge tightly**

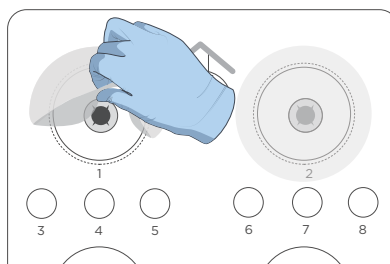
16. Lift the cartridge horizontally and hold both sides of the cartridge with both hands. Shake the cartridge 20 times in a clockwise and counterclockwise direction. Ensure that the reagents are fully mixed.



**Figure 14** Mixing reagents after loading

17. Carefully remove the seals from the loading wells after fully mixing.

- i** • Do not reuse the used the used sealing film.
- To prevent cross-contamination, ensure that the surface around wells No. 1 and No. 2 is clean.



**Figure 15** Removing the seal from the cartridge

18. Gently tap the cartridge on the bench to reduce air bubbles in the reagents.
19. Pierce the seal of well No. 15 by using a 1 mL sterile pipette tip.
20. Add 500  $\mu$ L of **MDA Enzyme Mix II** to the Inactive MDA Reagent tube with a 1 mL pipette.
- i** When using **MDA Enzyme Mix II**, do not touch the wall of the tube. The heat from your hands may affect the enzyme activity.
21. Invert the tube 6 times to mix the reagents.

22. Add all of the mixture to well No. 15. When adding the mixture, ensure that no bubbles appear at the bottom of the tube.



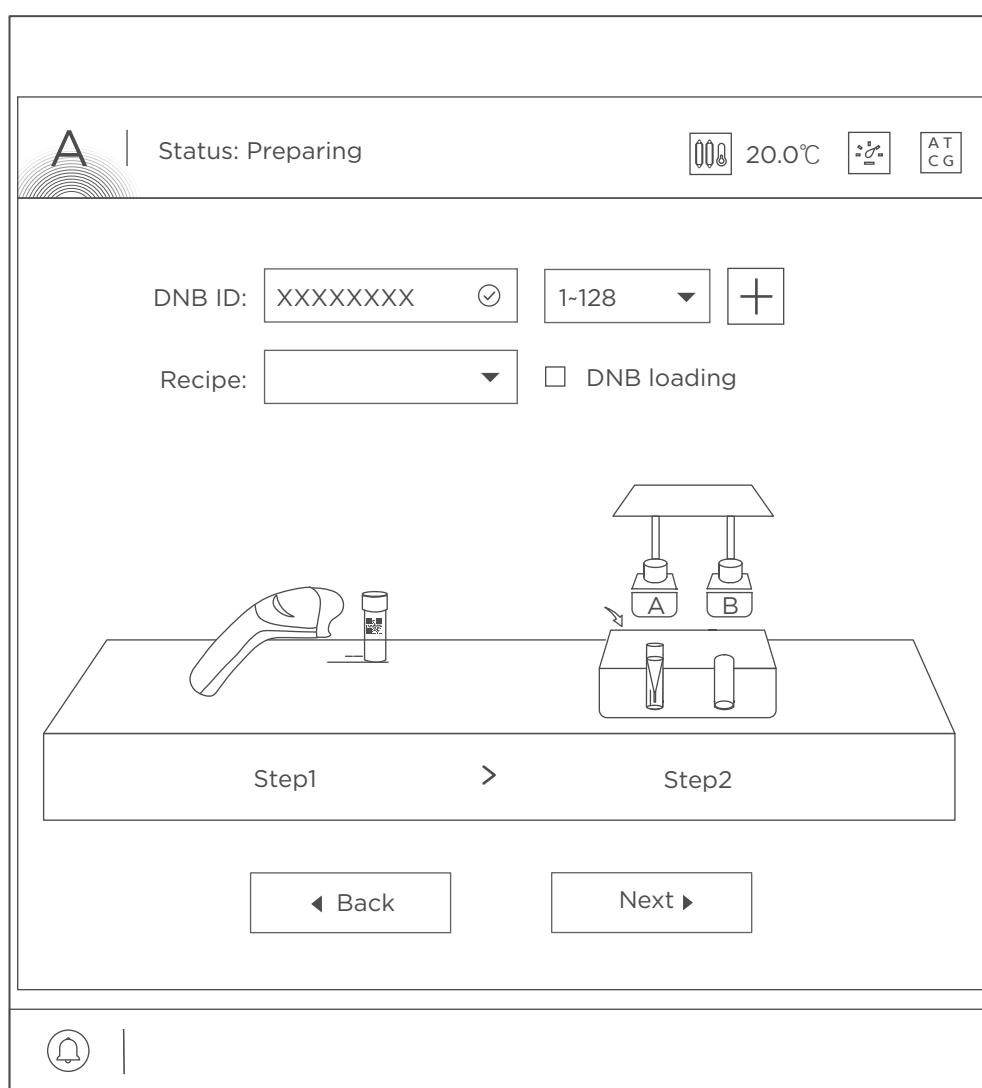
- When transferring the mixture, pipette carefully to prevent the mixture from spilling out of the reagent tube.
- Proceed to *Performing a sequencing run on Page 31*.

## Performing a sequencing run

### Entering DNB ID

Perform the following steps:

1. In the main interface, select **Sequence** to go to the DNB ID entry interface:



**Figure 16** DNB ID entry interface

2. Select the DNB ID box, scan the QR code on the tube, or enter the DNB ID manually by using the on-screen keyboard.
3. Select a barcode range of different lanes from the list next to the DNB ID box.

Select  or  to add or remove a line of DNB ID if needed.

**i** Select 4 lanes for FCL.

The screenshot shows a table-like interface for selecting DNB IDs. It has four rows, each representing a different DNB ID. Each row contains a text input field with a checkmark, a dropdown menu, and a button with a plus or minus sign.

DNB ID:	STO-1 <input checked="" type="checkbox"/>	1-128 ▼	<input type="checkbox"/>
	STO-2 <input checked="" type="checkbox"/>	1-128 ▼	<input type="checkbox"/>
	STO-3 <input checked="" type="checkbox"/>	1-128 ▼	<input type="checkbox"/>
	STO-4 <input checked="" type="checkbox"/>	1-128 ▼	<input type="checkbox"/>

**Figure 17 DNB information selection interface**

## Selecting sequencing parameters

Perform the following steps:

1. Select STO\_N\_25+59+10 or STO\_N\_25+59\_noBC recipe from the **Recipe** list for FFPE sequencing and select STO\_T\_50+100+10 or STO\_T\_50+100\_noBC recipe from the **Recipe** list for FF V1.3 sequencing.

The screenshot shows a 'Recipe:' label followed by a dropdown menu. The dropdown menu is open, showing a list of recipe options. To the right of the dropdown is a checkbox labeled 'DNB loading' which is checked.

Recipe: STO\_T\_50+100+10 ▼  DNB loading

- SE100
- SE400
- PE150
- STO\_N\_25+59+10
- STO\_N\_25+59+noBC
- STO\_T\_50+100+10
- STO\_T\_50+100+noBC
- Customize

**Figure 18 Selecting the sequencing recipe**

- i** For FF V1.3 sequencing: for barcode sequencing, select STO\_T\_50+100+10; otherwise select STO\_T\_50+100\_noBC.
- For OMNI FFPE sequencing: for barcode sequencing, select STO\_N\_25+59+10; otherwise select STO\_N\_25+59\_noBC.

2. If the DNBs are loaded by the sequencer, select DNB loading on the right of the **Recipe** list.

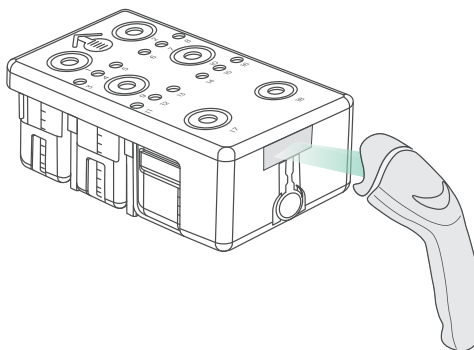
---

## Loading the Sequencing Reagent Cartridge

Perform the following steps:

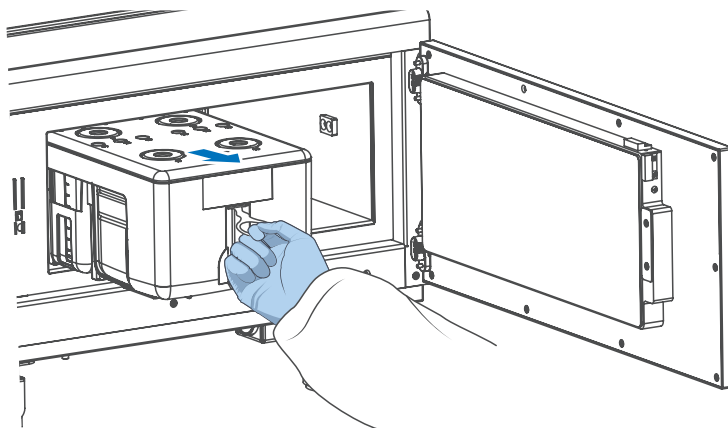
1. Select the **Sequencing cartridge ID** field, enter the cartridge ID manually or use the barcode scanner to scan the cartridge barcode at the lower-right corner of the Sequencing Reagent Cartridge label.

**i** The 14-digit serial number (SN) contains information about the manufacturing site (the first digit) and the type (the second and third digits) of the reagent. The first 3 digits out of 14 are W05.



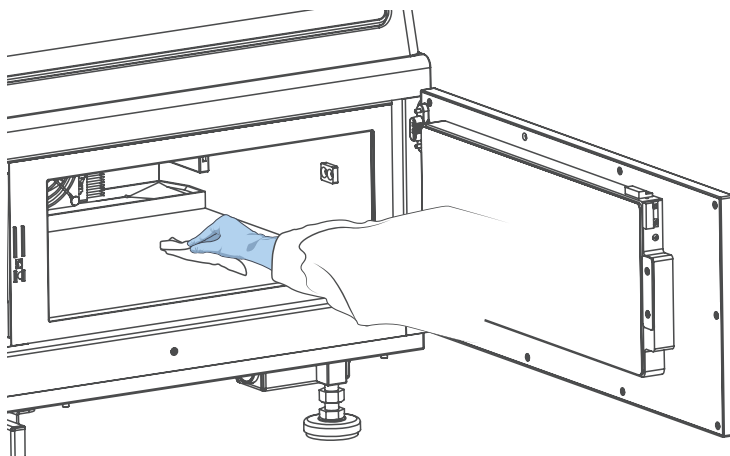
**Figure 19** Scanning the Sequencing Reagent Cartridge ID

2. Open the reagent compartment door and slowly remove the cleaning cartridge from the compartment.



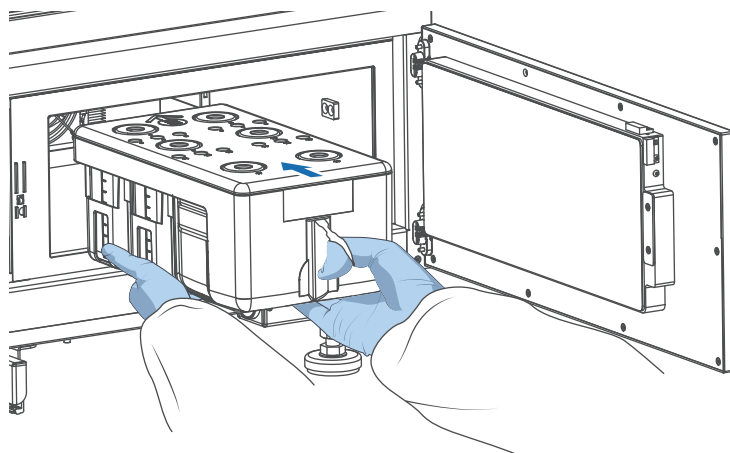
**Figure 20** Removing the cleaning cartridge

3. Moisten a KimWipes tissue with laboratory-grade water and use it to wipe the bottom and sides of the compartment to keep it clean and dry.



**Figure 21** Maintaining the reagent compartment

4. Hold the handle of the new Sequencing Reagent Cartridge with one hand and place the other hand underneath for support.
5. Slide the cartridge into the compartment until it stops. Follow the instructions printed on the cover of the cartridge.



**Figure 22** Sliding the new Sequencing Reagent Cartridge into the reagent compartment

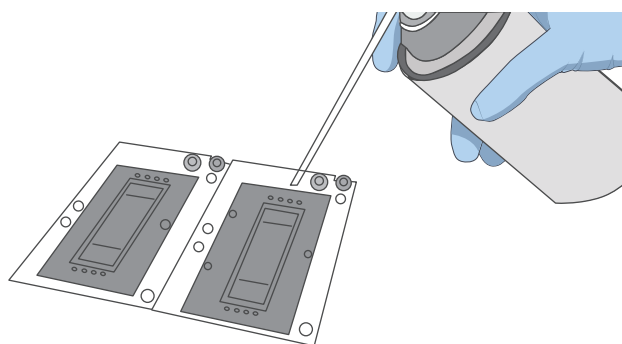
6. Ensure that the cartridge is in the correct position and then close the reagent compartment door.



## Loading the flow cell

Perform the following steps:

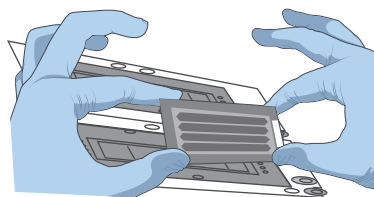
1. Open the flow cell compartment door.
2. Press both sides of the washing flow cell with one hand and press the flow cell attachment button with the other hand.
3. After the vacuum is released, remove the washing flow cell from the stage.
4. Use a canned air duster to remove the dust from the flow cell stage and the back of the flow cell.



**Figure 23** Cleaning the flow cell stage

**i** If there are impurities on the stage surface, gently wipe the surface with a wet KimWipe tissue to ensure that the flow cell can be held properly.

5. Take out a new flow cell or the loaded flow cell.
6. There are two alignment holes on the left side and one hole on the right side. The label is on the right. Hold the edges of the flow cell with both hands as shown in the figure below.



**Figure 24** Loading the flow cell

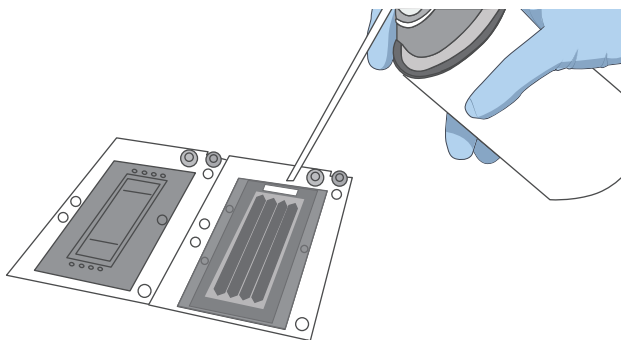
7. Align the holes on the flow cell with the locating pins on the flow cell stage. Gently slide the flow cell at an angle of 45 degrees to the upper-left corner to keep the flow cell aligned with the pin.
8. Press the flow cell attachment button. Press the left and right sides of the flow cell on the stage at the same time to ensure that the flow cell is properly seated on the stage.

**i** The flow cell is fragile; handle it with caution.

9. Ensure that the negative pressure is within the range of -80 kPa to -99 kPa before continuing.

If the negative pressure is abnormal, refer to *Q: What should I do if abnormal negative pressure appears during flow cell attachment?* on Page 57 in this guide for troubleshooting.

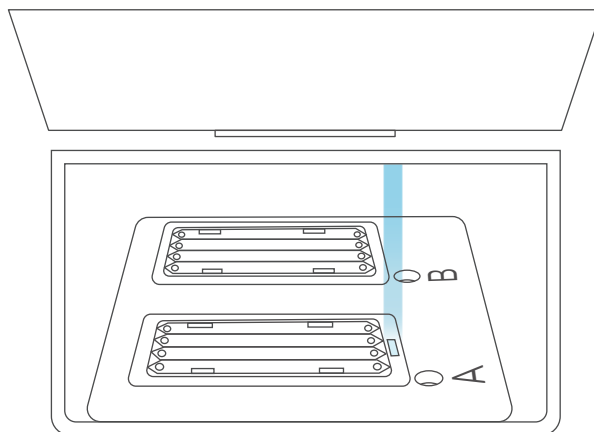
10. Use a canned air duster to remove the dust from the flow cell surface and then close the flow cell compartment door.



**Figure 25** Cleaning the flow cell


11. Select **Next**, and then the flow cell ID can be entered with the barcode scanner.


If automated entry does not work, and enter the ID manually in the Flow Cell ID box.



**Figure 26 Scanning flow cell ID**

12. Select **Next**.

 **WARNING** If the flow cell accidentally drops to the floor and breaks, handle with care to prevent personal injury.

 **CAUTION**

- If the flow cell is not attached properly, use a canned air duster to blow off the dust on the flow cell stage and the back of the flow cell. If there are crystals on the surface of the stage, wipe it gently with a damp Kimwipe tissue and then let it air-dry, to ensure that the flow cell can be firmly attached to the stage.
- Do not move the flow cell once it is loaded. Otherwise, it may cause misalignment between the flow cell inlet, outlet, and the gasket.

## Reviewing parameters

**i** To ensure sequencing quality, when sequencing of Read1 and Read2 is completed, the sequencer will automatically perform another cycle for calibration. For OMNI FFPE sequencing, the length of Read1 is 25, the length of Read2 is 59, and the length of barcode is 10. Adding 1 correction cycle for Read1 and 1 correction cycle for Read2 (barcode does not need to be corrected), the total number of sequencing cycles is 96. For FF v1.3 sequencing, the length of Read1 is 50 (dark reaction cycle is from 26 to 40), the length of Read2 is 100, and the length of barcode is 10. Adding 1 correction cycle for Read1 and 1 correction cycle for Read2 (barcode does not need to be corrected), the total number of sequencing cycles is 162.

Review	
Item	Content
User name	user
DNB ID Lane 1	STO-1   1 ~ 128
DNB ID Lane 2	STO-2   1 ~ 128
DNB ID Lane 3	STO-3   1 ~ 128
DNB ID Lane 4	STO-4   1 ~ 128
Sequencing cartridge ID	W05000012
Flow cell ID	V300001234
Recipe	STO_N_25+59+10
Start phase	DNB Loading
Cycles	96

**Figure 27** Reviewing information for OMNI FFPE

Review	
Item	Content
User name	user
DNB ID Lane 1	STO-1   1 ~ 128
DNB ID Lane 2	STO-2   1 ~ 128
DNB ID Lane 3	STO-3   1 ~ 128
DNB ID Lane 4	STO-4   1 ~ 128
Sequencing cartridge ID	W05000012
Flow cell ID	V300001234
Recipe	STO_T_50+100+10
Start phase	DNB Loading
Cycles	162

**Figure 28** Reviewing information for FF V1.3

Carefully check each item in the review interface, and do one of the following:

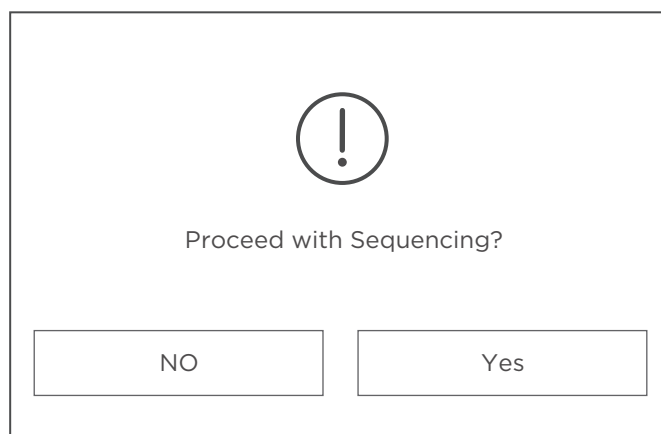
- If you find errors, select **Previous** to return to the previous interface and reset.
- If all parameters are correct, select **Start**. The software automatically checks the available storage drive space:
  - If the storage space is sufficient, a confirmation dialog box appears. Select **Yes** to start a sequencing run.
  - If the storage space is insufficient, perform the following steps:
    - a. In the prompted dialog box, select the data that you want to delete and select **Clear history data**.
    - b. When the storage drive space icon turns green, select **Back** to return to the parameter review interface, and then select **Start**.

---

## Starting sequencing

Perform the following steps:

1. After confirming that the information is correct, select **Start** and then select **Yes** when prompted to begin sequencing.



**Figure 29** Confirming sequencing interface

2. When sequencing has started, immediately open the flow cell compartment door to inspect the flow cells, and ensure that the DNBs or reagents are flowing through the flow cell.



- CAUTION**
- Do not bump, move, vibrate, or impact the device during sequencing, as it may cause inaccurate sequencing results.
  - If malfunctions related to fluidics lines (for example, bubbles) occur during sequencing, fix the problems before you restart sequencing. For details, refer to *FAQs on Page 53*.
  - Pay special attention to the LED status indicator or the on-screen instructions. If errors occur, troubleshoot the problem by following the instructions and this guide. If errors persist, contact CG Technical Support.

3. Sequencing is finished when the interface is idle or when processing data is displayed. Perform the wash process according to *Wash on Page 44*.

---


## Performing a maintenance wash

After the sequencing run, perform a maintenance wash within 24 hr.

For details, refer to *Performing a maintenance wash (~94 min) on Page 48*.

---

## Disposing of the Sequencing Reagent Cartridge and flow cell

 **WARNING** If the flow cell accidentally drops to the floor and breaks, handle with care to prevent personal injury.

Perform the following steps:

1. Wear protective equipment.
2. Open the flow cell compartment and remove the flow cell:
  - 1) Hold the flow cell by the edges with one hand to prevent the flow cell from falling into the device, and to avoid damage to the flow cell.
  - 2) Press the flow cell attachment button with the other hand to release the flow cell. Remove the flow cell.
3. Open the reagent compartment door, pull out the Sequencing Reagent Cartridge by using the pull ring and remove the cartridge. Move up the base, and remove the tube.
4. Empty the remaining solution in the Sequencing Reagent Cartridge and tube into an appropriate waste container.
5. Dispose of the tube, flow cell, and Sequencing Reagent Cartridge in accordance with local regulations and safety standards of your laboratory.



---This page is intentionally left blank.---



# 03

## Device maintenance

This chapter describes maintenance procedures for the device and its components. Perform maintenance regularly to ensure that the device runs smoothly.

-  **DANGER**
  - Ensure that the device is powered off before cleaning or disinfecting to avoid personal injury.
  - Do not spray the wash solutions or disinfectants into the device during cleaning or disinfecting to avoid device damage.
-  **WARNING**
  - It is not recommended to use other disinfectants or wash solutions except for those that are mentioned in this guide. Other solutions are not verified for use and their effects on the device are unknown.
  - If you have questions about the compatibility of wash solutions, contact CG Technical Support.

---

## Service plan

A free preventive maintenance service is provided in the first year during the warranty period. To purchase additional services, please contact CG Technical Support.

---

## Sequencer maintenance

---

### Wash

---

#### Wash type introductions

There are two different wash types based on sequencer conditions:

**Table 21** Wash type introductions

Wash protocol	Wash type	Cartridge type	Description
Pre-run wash	Regular (54 min)	Cleaning cartridge 1 (Laboratory-grade water)	<ul style="list-style-type: none"> <li>• Before a sequencing run.</li> <li>• Maintenance wash has been performed more than 24 hr earlier.</li> </ul>

Wash protocol	Wash type	Cartridge type	Description
Maintenance wash	Maintenance (20 min)	Cleaning cartridge 3 (Tween-20)	<ul style="list-style-type: none"> <li>It has been more than 7 d since the last operation, and a pop-up dialog box indicates a wash.</li> <li>When using the control software for the first time, updating to a new version, or manually clearing data resulting in no records, a pop-up dialog box indicates a wash.</li> <li>After an PE sequencing run or DNB loading.</li> <li>After the sequencer maintenance is performed by an engineer. This includes, but is not limited to the replacement of pipelines, sample needles and other accessories exposed to reagents.</li> <li>If the sequencer is to be powered off for more than 7 d, a wash before being powered off and after being powered on is required.</li> <li>When impurities are visible on the flow cell.</li> </ul>
	Maintenance (20 min)	Cleaning cartridge 2 (NaOH)	
	Regular (54 min)	Cleaning cartridge 1 (Laboratory-grade water)	
DNBTube wash (Optional)	DNBTube (5 min)	Cleaning cartridge 1 (Laboratory-grade water)	If you need an extra wash for the DNB loading tubes after pre-wash and maintenance wash.
	DNBTube (5 min)		
	DNBTube (5 min)		

**Preparing for wash**

**Preparing washing reagents**

Prepare the washing reagents according to table below:

**Table 22 Washing reagent 1: 0.05% Tween-20**

Reagent name	Volume (mL)	Final concentration
100% Tween-20	0.5	0.05%

Laboratory-grade water	999.5	N/A
<b>Total volume</b>	1000	
<b>Shelf life</b>	1 month at 2 °C to 8 °C	

**Table 23 Washing reagent 2: 0.05% Tween-20+1 M NaCl**

Reagent name	Volume (mL)	Final concentration
100% Tween-20	0.5	0.05%
5 M NaCl solution	200	1 M
Laboratory-grade water	799.5	N/A
<b>Total volume</b>	1000	
<b>Shelf life</b>	1 month at 2 °C to 8 °C	

**Table 24 Washing reagent 3: 0.1 M NaOH**

Reagent name	Volume (mL)	Final concentration
2 M NaOH	50	0.1 M
Laboratory-grade water	950	N/A
<b>Total volume</b>	1000	
<b>Shelf life</b>	1 month at 2 °C to 8 °C	

## Preparing cleaning cartridges, DNB loading needle washing tubes, and washing flow cell

### Preparing cleaning cartridges

Fill the cleaning cartridges with washing reagents according to the table below:

**Table 25 Reagents and volume of the cleaning cartridges**

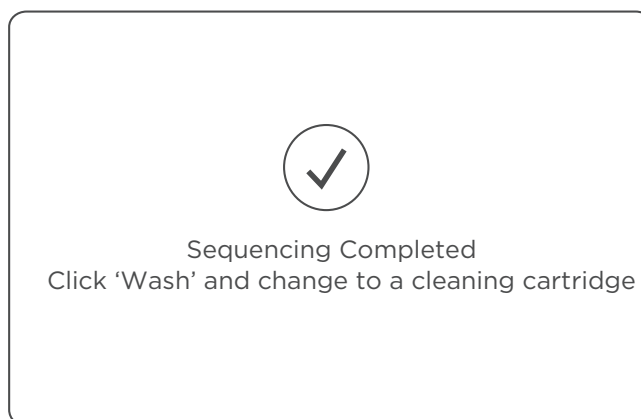
Cleaning cartridges	Well position	Washing reagent	Volume (mL)
Cleaning cartridge 1	1, 9, 10	Laboratory-grade water	300
	2		380
	17, 18		700
	3, 4, 5, 6, 7, 8, 11, 12, 13, 14, 15, 16 (all small wells)		9

Cleaning cartridges	Well position	Washing reagent	Volume (mL)
Cleaning cartridge 2	1, 2, 9, 10, 17, 18	Washing reagent 3: 0.1 M NaOH	50
	3, 4, 5, 6, 7, 8, 11, 12, 13, 14, 15, 16 (all small wells)		8.5
Cleaning cartridge 3	1, 2, 9, 10, 17, 18	Washing reagent 1: 0.05% Tween-20	50
	3, 4, 5, 6, 7, 8, 11, 12, 13, 14, 16 (all small wells, except 15)		8.5
	15 (small well)	Washing reagent 2: 0.05% Tween-20+1 M NaCl	8.5

## Performing a wash

### Selecting wash

When the sequencing run is completed, the device must be washed within 24 hr. When the following interface appears, select **Wash** and perform the wash procedures.



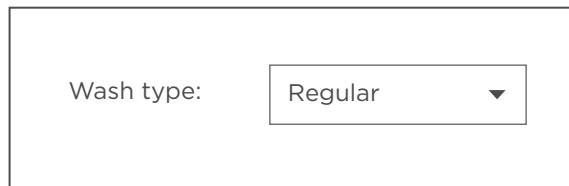
**Figure 30** Wash instructions interface

### Performing a pre-run wash (~54 min)

Perform the following steps:

1. Slowly insert cleaning cartridge 1 into the reagent compartment until it stops. Follow the instructions printed on the cartridge cover.

- Put the DNB loading needle washing tube 1 (sterile microcentrifuge tube, 2.0 mL with 1.8 mL [Laboratory-grade water](#)) into the DNB loading position. Close the reagent compartment door.
  - Load the washing flow cell. Ensure that the washing flow cell is properly loaded. For details, refer to *Loading the flow cell on Page 35*.
  - Select **Wash** in the main interface. Select Regular from the Wash type list to start pre-run wash, which takes approximately 54 min.
- i** When you perform the wash, observe the status of the washing flow cell. If bubbles are visible, stop the wash, replace the flow cell, and re-start the wash. If no bubbles are observed, continue the wash.



**Figure 31** Selecting the wash type

### Performing a maintenance wash (~94 min)

Perform the following steps:

- Insert the cleaning cartridge 3 into the reagent compartment until it stops. Follow the instructions printed on the cartridge cover.
- Put DNB loading needle washing tube 3 (sterile microcentrifuge tube, 2.0 mL with 1.8 mL [Tween-20](#)) into the DNB loading position. Close the reagent compartment door.
- Place the washing flow cell on the stage. Ensure that the washing flow cell is properly seated.  
For details, refer to *Loading the flow cell on Page 35*.
- Select **Wash** in the wash instructions interface. Select Maintenance from the Wash type list to start the wash. The wash takes approximately 20 min.

- When the interface appears as shown in the figure below, select **Yes** and the sequencer will automatically lift the sampling needles.



**Figure 32 Maintenance wash [2] prompt**

- Insert the cleaning cartridge 2 into the reagent compartment until it stops. Follow the instructions printed on the cartridge cover.
- Put DNB loading needle washing tube 2 (sterile microcentrifuge tube, 2.0 mL with 1.8 mL NaOH) into the DNB loading position. Close the reagent compartment door.
- Select **Wash** in the wash instructions interface. Select Maintenance from the Wash type list to start the wash. The wash takes approximately 20 min.
- When the interface appears as shown in the figure below, select **No** and the sequencer will automatically lift the sampling needles.



**Figure 33 Maintenance wash [3] prompt**

- Insert the cleaning cartridge 1 into the reagent compartment until it stops. Follow the instructions printed on the cartridge cover.
- Put DNB loading needle washing tube 1 (sterile microcentrifuge tube, 2.0 mL with 1.8 mL Laboratory-grade water) into the DNB loading position.
- Close the reagent compartment door.

13. Select **Wash** in the wash instructions interface. Select Regular from the Wash type list to start the wash. The wash takes approximately 54 min.

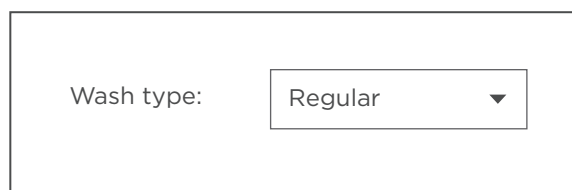
### (Optional) Performing a DNBTube wash (~15 min)

Once the pre-run wash and maintenance wash are completed, if you need another wash for the DNB loading tubes, perform the following steps:

1. Slowly insert the Cleaning cartridge 1 into the reagent compartment by following the direction printed on the cartridge cover until it stops.
2. Place DNB loading needle washing tube 3 (2.0 mL sterile microcentrifuge tube with 1.8 mL Tween-20) into the DNB tube rack. Close the reagent compartment door.
3. Place the washing flow cell on the stage. Ensure that the washing flow cell is properly seated.

For details, refer to *Loading the flow cell on Page 35*.

4. Select **Wash** in the main interface. Select DNBTube from the Wash type list to start the wash. The wash takes approximately 5 min.



**Figure 34** Selecting DNBTube

5. Select **Back** to return to the main interface.
6. Place the DNB loading needle washing tube 2 (2.0 mL sterile microcentrifuge tube with 1.8 mL NaOH) into the DNB tube rack. Close the reagent compartment door.
7. Repeat steps 4 through 5.
8. Place DNB loading needle washing tube 1 (2.0 mL sterile microcentrifuge tube with 1.8 mL Laboratory-grade water) into the DNB tube rack.
9. Select **Wash** in the main interface. Select DNBTube from the Wash type list to start the wash. The wash takes approximately 5 min.

---

### Reusing the cleaning cartridge

The sequencer cleaning cartridge and washing flow cell are provided together with the device.



Rinse the sequencer cleaning cartridge before refilling with washing reagents. Replace a sequencer cleaning cartridge after it has been used 20 times or every 6 months.

---This page is intentionally left blank.---

# 04

## FAQs

This chapter describes frequently asked questions about the reagents.

If malfunctions occur during operation, the device sounds an alarm or a message is displayed on the screen. Follow the prompts to troubleshoot and solve the issue.

If the problem persists after you try the recommended actions, contact CG Technical Support.

---

## Reagent FAQs

---

### Q: What should I do if the DNB concentration is low?

When the DNB concentration is less than that specified in *Quantifying DNBs on Page 16*, perform the following steps:

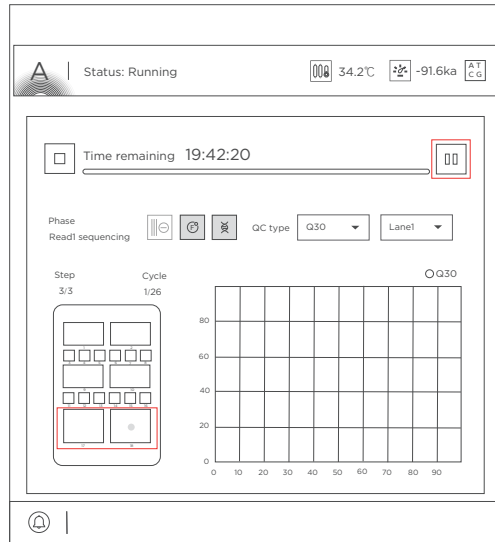
1. Check whether the DNB preparation kit has expired.
2. Check whether the libraries meet the requirements.
3. Make a new DNB preparation. If the DNB concentration still does not meet the requirements after a new sample preparation, contact CG Technical Support.

---

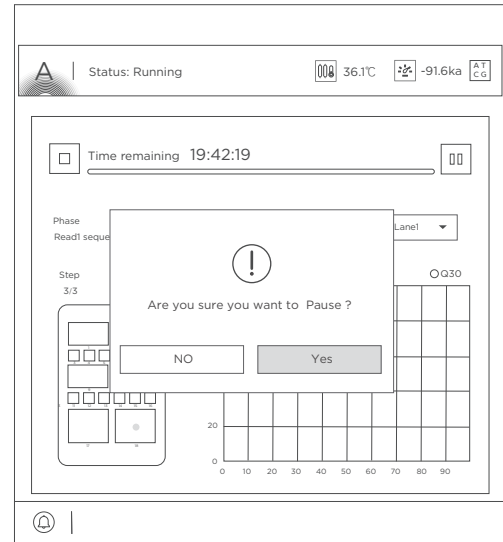
### Q: What should I do if I forget to add reagent into well No. 15 for PE sequencing run?

MDA Enzyme is required to make the second strand template for PE sequencing. When preparing the Sequencing Reagent Cartridge, the appropriate amounts of *MDA Enzyme Mix II* and *Inactive MDA Reagent* need be added to well No. 15. If you mistakenly forget to add the reagent into well No. 15 before starting the sequencing run, this can be resolved by performing the following steps if the sequencing run is in the sequencing phase of Read1.


1. Pause the run: At any sequencing cycle within Read1, while sequencing is at Step 3/3, and the indicator is at well No. 17 or well No. 18, select  , and select **Yes** when you are prompted, as shown in the following two figures.

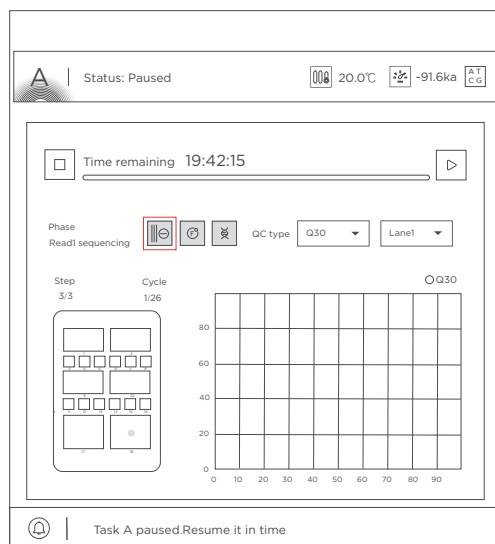


**Figure 35** Selecting the sequencing stage to pause

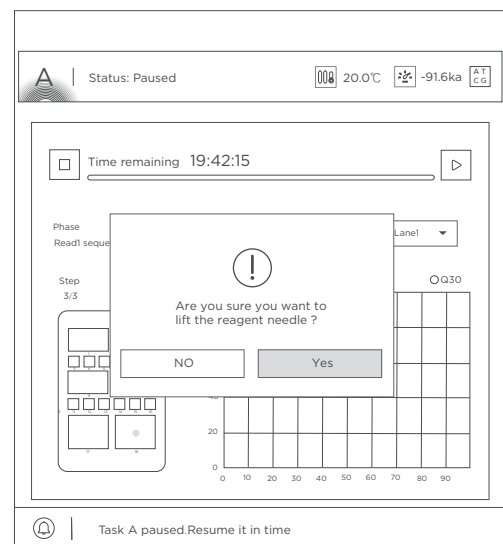


**Figure 36** Confirming to pause the run

2. Lift the needle: Select  to lift the needle, and select **Yes** when you are prompted, as shown in the following two figures.




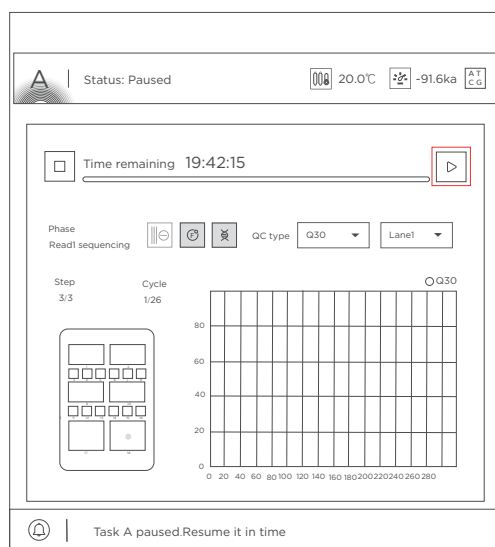
**Figure 37** Selecting to lift the needle



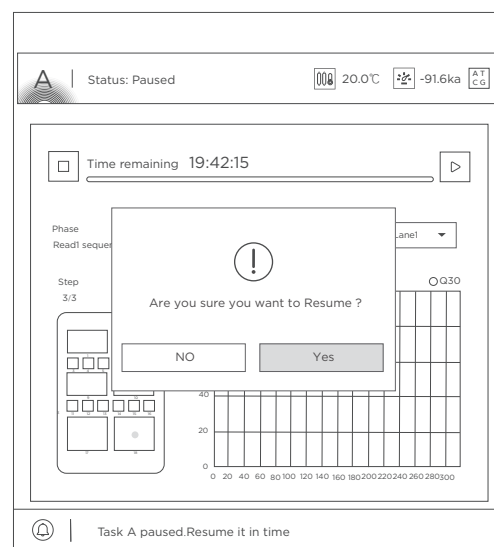
**Figure 38** Confirming to lift the needle

3. Prepare the Sequencing Reagent Cartridge: Open the reagent compartment door and take out the Sequencing Reagent Cartridge. Add the appropriate amount of [MDA Enzyme Mix II](#) into [Inactive MDA Reagent](#) tube, mix well and add all of the mixture to well No. 15 according to [Preparing the Sequencing Reagent Cartridge on Page 24](#).

4. Resume the run: Put the cartridge back to the sequencer and close the reagent compartment door. Select  to resume the run, and select **Yes** when you are prompted, as shown in the following two figures.



**Figure 39** Selecting to resume the run



**Figure 40** Confirming to resume the run

After the sequencing run is resumed, the sampling needles automatically move down. The sequencer continues to pump reagents into the flow cell. The Read1 sequencing phase continues.

## Q: What rules should I follow if I need to store a reagent kit temporarily?

- If a kit has been thawed (not including dNTPs) but cannot be used within 24 hr, it can be frozen and thawed at most one time.
- If a kit has been thawed (including dNTPs) but cannot be used immediately, store it at 2 °C to 8 °C. It is strongly recommended to use it within 24 hr. Mix the reagents in the cartridge following the instructions in *Preparing the Sequencing Reagent Cartridge on Page 24* before use.
- If dNTPs and Sequencing Enzyme Mix II have been added into the cartridge; that is, the cartridge has been prepared but cannot be used immediately, store it at 2 °C to 8 °C and use it within 24 hr. Mix the reagents in the cartridge following the instructions in *Preparing the Sequencing Reagent Cartridge on Page 24* before use.
- If dNTPs and Sequencing Enzyme Mix II have been added into the cartridge; that is, the cartridge has been prepared and the needles have punctured the seal, but the cartridge cannot be used immediately, the cartridge must be sealed with foil or plastic wrap. Store the cartridge at 2 °C to 8 °C and use it within

24 hr. Gently mix the reagents in the cartridge before use. To prevent reagent contamination when mixing, be careful not to spill any reagent from the needle holes.

---

### **Q: What should I do if abnormal negative pressure appears during flow cell attachment?**

When the negative pressure is shown in red, the negative pressure is abnormal. Perform the following steps:

1. Gently wipe the stage surface of flow cell stage with a damp KimWipes tissue and remove dust from the stage with a canned air duster. Ensure that no dust is present on the flow cell stage.
2. Remove dust from the back of the flow cell with a canned air duster to ensure that no dust is present.
3. If the problem persists, contact CG Technical Support.

---

### **Q: What should I do if a pumping failure occurs during DNB loading and sequencing?**

If liquids cannot be pumped onto the flow cell, or large bubbles appear in the flow cell, perform the following steps:

1. The sequencer: remove the flow cell, check for impurities in the sealing gasket and remove any dust with a canned air duster. Inspect the pump. Insert a new flow cell by following the instructions in *Loading the flow cell on Page 35* and start the pump again.
2. Confirm that if the sampling needles are moving properly. If the sampling needles are not moving properly, restart the control software of the sequencer.
3. If the problem persists, contact CG Technical Support.

---

### **Q: What should I do if impurities appear in the original sequencing image?**

If impurities appear, perform the following steps:

1. Moisten a KimWipes tissue with 75% ethanol and use it to wipe the sealing gaskets on the flow cell stage and perform a maintenance wash on the sequencer according to *Performing a maintenance wash (-94 min) on Page 48*.
2. If the problem persists after a full wash, contact CG Technical Support.

---This page is intentionally left blank.---



# Instructions for using Qubit to quantify the DNBs

- i** • Working solution should be used within 30 min following preparation.
- Avoid touching the wall of tapered detection tubes.
- Avoid introducing bubbles in detection tubes.

Perform the following steps:

1. Prepare Qubit working solution by diluting Qubit ssDNA Reagent 1:200 in Qubit ssDNA Buffer. Use a clean Qubit assay tube each time you prepare Qubit working solution. Do not mix the working solution in a glass container.

- i** The final volume in each tube must be 200 µL. Each standard tube requires 190 µL of Qubit working solution, and each sample tube requires from 180-199 µL of Qubit working solution.

Prepare sufficient Qubit working solution to accommodate all standards and samples.

For example: for 8 samples, prepare enough working solution for the samples and 2 standards. ~200 µL per tube in 10 tubes yields a total of 2 mL of working solution (10 µL of Qubit reagent plus 1990 µL of Qubit Buffer).

2. Add 190 µL of Qubit working solution to each tube used for standards.
3. Add 10 µL of each Qubit standard to the appropriate tube and mix by vortexing 3-5 sec. Be careful not to create bubbles.
4. Set up the required number of 0.5-mL tubes for standards and samples. The Qubit ssDNA Assay requires 2 standards.
  - i** • Use only thin-wall, clear, 0.5-mL PCR tubes. Acceptable tubes include Qubit assay tubes (Cat. No.: Q32856) or Axygen PCR-05-C tubes (Part No.: 10011-830).
  - The number of Qubit test tubes needed are the number of samples plus 2 standards tubes. For example, if you have 3 samples, you will need 5 tubes.
5. Label the tube lids. Do not label the side of tube.
6. Prepare the solutions used for standards and sample tests according to the table below:

Component	S1 (µL)	S2 (µL)	D1 (µL)	D2 (µL)	D3 (µL)
Working solution	190	190	198	198	198

Component	S1 ( $\mu\text{L}$ )	S2 ( $\mu\text{L}$ )	D1 ( $\mu\text{L}$ )	D2 ( $\mu\text{L}$ )	D3 ( $\mu\text{L}$ )
S1 (0 ng/ $\mu\text{L}$ )	10	/	/	/	/
S2 (20 ng/ $\mu\text{L}$ )	/	10	/	/	/
Sample ( $\mu\text{L}$ )	/	/	2	2	2
Total volume	200	200	200	200	200

- Mix the tubes by using a vortex mixer and centrifuge briefly for 5 sec. Incubate at room temperature for 2 min.
- Refer to the Qubit user manual for instructions on reading standards and samples. Follow the appropriate procedure for your instrument.

9.

---

## Research use only

Complete Genomics has labeled the product solely for research use only and specified “RS” in the model name which means it should not be used for clinical diagnosis. Please refer to FDA Guidance, *Distribution of In Vitro Diagnostic Products Labeled for Research Use Only or Investigational Use Only* (Nov. 2013) (available at: <https://www.fda.gov/media/87374/download>). If you have any question, please contact Complete Genomics at +1 (888) 811-9644.

---This page is intentionally left blank.---

# Manufacturer information

<b>Manufacturer</b>	Complete Genomics, Inc.
<b>Address</b>	2904 Orchard Parkway, San Jose, CA 95134
<b>Customer service telephone</b>	+1 (888) 811-9644
<b>Customer service Email</b>	US-CustomerService@CompleteGenomics.com
<b>Technical support Email</b>	US-TechSupport@CompleteGenomics.com
<b>Website</b>	www.completegenomics.com

---This page is intentionally left blank.---

---

## Order information

Catalog number	Model	Name	Version	Recommended brand
940-001885-00	G400 STO FCL PE75	DNBSEQ-G400RS Stereo-seq Visualization Reagent Set	1.0	CG
900-000696-00	DL-200H	Portable DNB Loader	1.0	CG
940-000870-00	400	Sequencer Cleaning Cartridge	1.0	CG

---This page is intentionally left blank.---



---

## Acronyms and abbreviations

Item	Description
bp	Base-pair
DL-200H	Portable DNB Loader (For DNBSEQ-G400)
DNA	Deoxyribonucleic Acid
DNB	DNA Nanoball
dsDNA	double-stranded DNA
FAQ	Frequently Asked Questions
FCL	Flow Cell Large, 4 lanes per flow cell in DNBSEQ-G400RS Sequencing FCL Flow Cell
PE	Paired-end sequencing
QC	Quality Control
RCA	Rolling Circle Amplification
ssDNA	single-stranded DNA
MDA	Multiple Displacement Amplification
PCR	Polymerase Chain Reaction
dNTP	deoxy-ribonucleoside triphosphate